

ELMARK[®]

The Brand of Electricity

Instruction and function of ADL 200



1. Overview

The DL200 single-phase power meter is designed to measure single-phase active energy in a low-voltage system, and at the same time it can measure electrical parameters such as voltage, current, power, etc. RS485 communication can also be selected. This electricity meter has the advantages of smaller volume, high precision, good electromagnetic compatibility, easy installation, etc. All meters meet the related technical requirements of the electricity meter in IEC62053-21、IEC62053-22 standards.

Catalog Number: 50219

2. Functions

Function	Function description	Function provide
Measurement of kWh	Single-phase active kWh (positive and negative), 3 months historical energy data frozen storage	■
Measurement of electrical parameters	Voltage, Current, Active power, Reactive power, Apparent power, Power factor and Frequency	■
LCD Display	8 bits section LCD display	■
Key programming	3 keys to set parameters like code, address, baud rate, multi-tariff and communication protocol	■
Pulse output	Active energy pulse output	■
Multi-tariff	Adapt 4 time zones, 2 time interval lists, 14 time interval by day and 4 tariff rates	<input type="checkbox"/> F
Communication	Communication interface: RS485, Communication protocol: MODBUS-RTU	■

(■: Standard; □: Optional)

3 Technical data

3.1 Electric performance

Input voltage	Reference voltage	AC 220V
	Reference frequency	50Hz
	Power consumption	<10VA
Input current	Basic current	10A
	Maximum current	80A
	Starting current	4%I _b
	Consumption	<4VA
Measurement performance	Accuracy of measuring	1 class
	Range of measuring	000000.00~99999999kWh
Clock accuracy		Error≤0.5s/d
Active pulse	Pulse width	80±20ms
	Pulse constant	1000imp/kWh
Communication	Interface	RS485(A+, B-)
	Connection mode	Shielded twisted pair conductors
	Protocol	MODBUS-RTU

3.2 Mechanical performance

Outline	Length ×	90mm×36mm×65mm
	Width ×	
	Height	
Strong current terminal Torque	<1.8Nm	

3.3 Work environment

Temperature range	Work temperature	-25℃~55℃
	Storage Temperature	-40℃~70℃
Relative humidity		≤95%(No condensation)
Altitude		<2000m

4. Dimensions

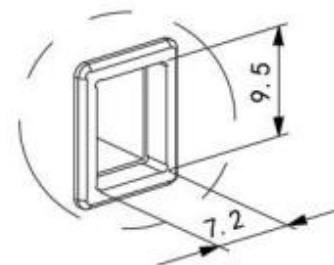
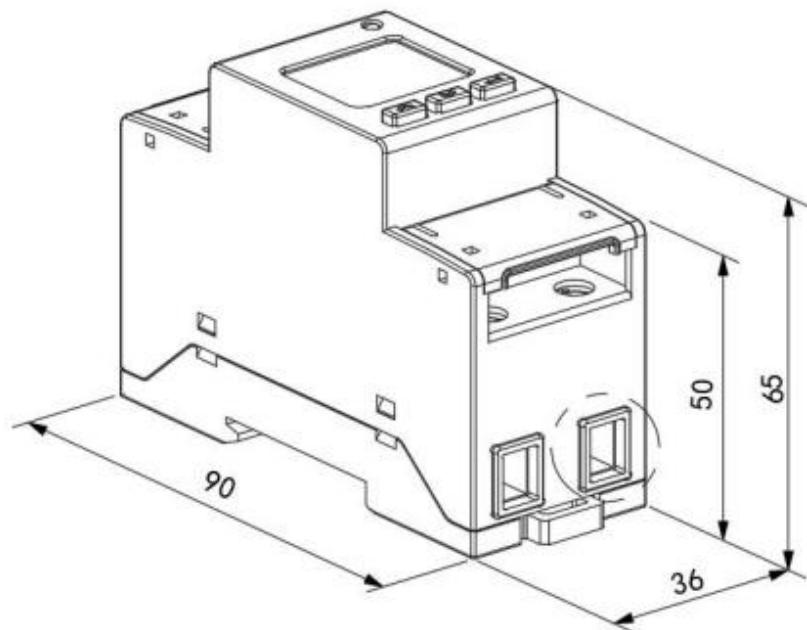

5. Wiring and installation

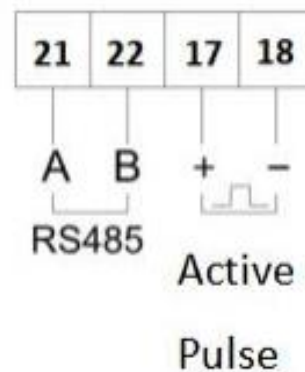
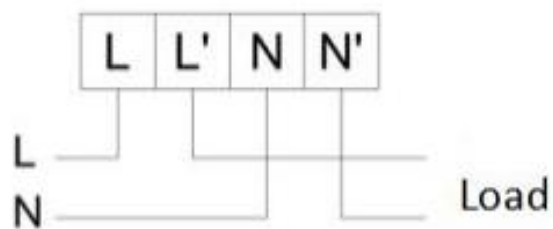

6. Diagnosis, analysis and elimination of common faul

6.1 Auxiliary power failure

Failure performance: the meter flashes and does not light up after being powered on.

Troubleshooting: 1. Check whether the wiring of the auxiliary power supply is consistent with the wiring diagram of the instrument, and whether the wiring is loose or falling off;

2. Use a multimeter to measure whether the input voltage value of the auxiliary power supply is within the normal working voltage range of the instrument.

6.2 Signal input failure

Failure performance: After the meter is powered on, the display power or energy count is not accurate. Troubleshooting: Switch the display interface of the meter to the power (active P, power factor λ) interface, check whether the power display is negative and whether the power factor is between 0.9-0.95, and then check whether the input and output of the current signal line are reversed (That is, the incoming line of the current must be consistent with the incoming end of the instrument), And consistent with the wiring on the meter.

6.3 communication failure



Failure performance: After the meter is powered on, it cannot communicate with the host computer normally.

Troubleshooting: 1. The voltage value between the communication output A and B of the measuring instrument should be between +(4.4-4.5)V;

2. Check whether the communication wiring method is correctly wired according to the wiring diagram (that is, the communication terminal A/B of the instrument should correspond to the communication serial port A/B



7. Operation and display

7.1 Key description

Key icon	Key name	Key function
	Key up	View voltage and current in the view interface Up and flashing shift in the programming interface
	Key down	View power in the view interface Scroll down and modify flashing bits in the programming interface
	Key setting	View electrical energy in the viewing interface Long press 3S to enter/exit the menu Short press OK in the programming interface to save the settings

7.2 display description

Show total energy when connected. Change information while pressing down key. Display information as following:

	U, I, F, Time, MODBUS Address, Baud, parity, Version, ALL—display;
	Total active power, total reactive power, total apparent power, total power factor;
	Total active energy, forward active total energy, reverse active total energy, total

Note:

- Listed above are the names of all display interfaces of the ADL200 meter with double rate function. Three buttons can switch different types of display content, the switching sequence is as described above;
- For the ADL200 meter without the double rate function, it does not display the date, time and various types of time-sharing energy (the energy in the four rate periods of sharp, peak, flat and valley).

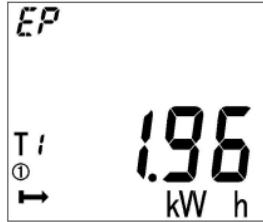

Current total active energy

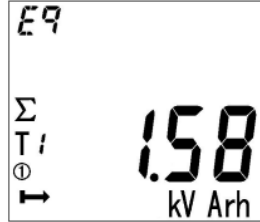

Current total reactive energy



Voltage



Current

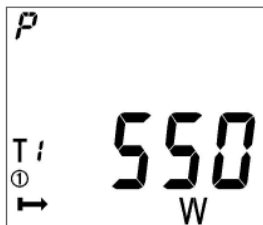

Current total active power 550W

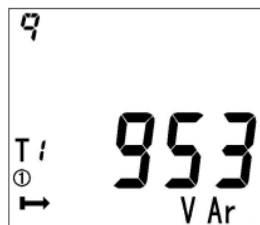

Current total reactive power 953VAr

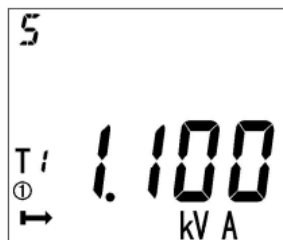

Current total apparent power 1.100kVA



Current total power factor 0.500

Note: The above is just a part of the display interface. The display mode of other interfaces is similar to the above figure. You can judge the display meaning according to the information displayed on the interface.

7.3 Programming display menu

Press at any main menu and get in **PASS** interface, and then press show **P-0000**, and enter the code. If you enter a wrong code, it will show "0000" and enter the code again; and if you enter a right code, you can set the parameter. After setting the parameter, it will show **SAVE** and save the change by pressing and quit without save by pressing .

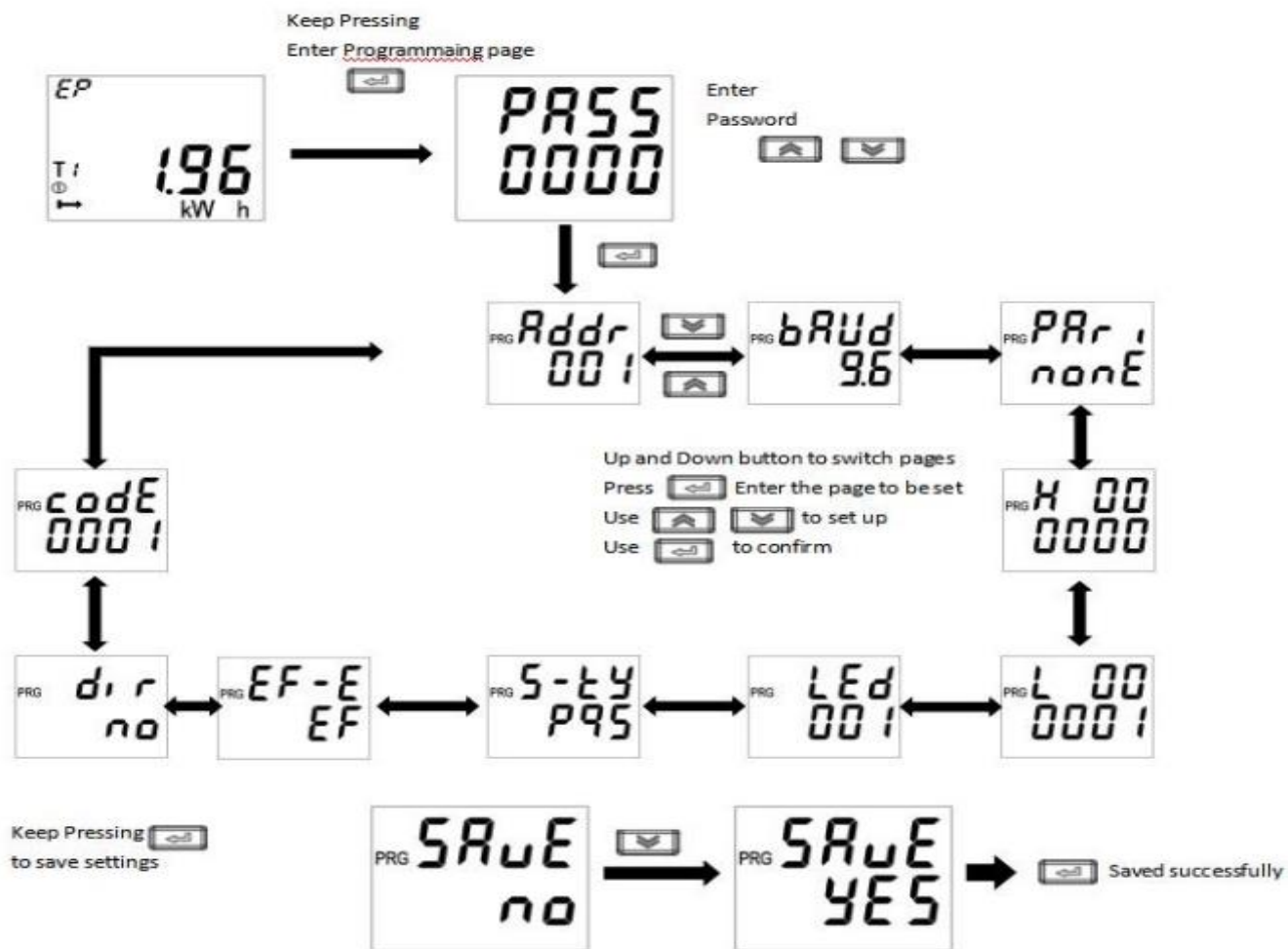

8. Communication descripti

8.1 Communication protocol

The meters adapt Modbus . Please refer to the relevant standards for more information. The multi-tariff data mean nothing when multi-tariff function (F) is not ap

8.2 MODBUS Address list

Address	Variable	Length	Attribut es	Note
0000H	Current combined total active energy	4	R	unit: 0.01kWh
0002H	Current combined spike active energy	4	R	
0004H	Current combined peak active energy	4	R	
0006H	Current combined flat active energy	4	R	
0008H	Current combined valley active energy	4	R	
000AH	Code	2	R	
000BH	Voltage	2	R	unit: 0.1V
000CH	Current	2	R	unit: 0.01A
000DH	Active power	2	R	unit: 0.001kW
000EH	Reactive power	2	R	unit: 0.001kvar
000FH	Apparent power	2	R	unit: 0.001kVA
0010H	power factor	2	R	unit: 0.001
0011H	Frequency	2	R	unit: 0.01Hz
0012H	Year, month	2	R/W	
0013H	Day, hour	2	R/W	
0014H	Minute, second	2	R/W	
0015H	Address	1	R/W	0~254
0015H	Communication baud rate	1	R/W	00:1200 01:2400 02:4800 03:9600 04:19200
0016H	light time	2	R/W	
0017H~ 0021H	Reserve			
0022H	Total active energy of last month	4	R	unit: 0.01kWh
0024H	Spike active energy of last month	4	R	
0026H	Peak active energy of last month	4	R	
0028H	Flat active energy of last month	4	R	
002AH	Valley active energy of last month	4	R	
002CH	Total active energy of last 2 month	4	R	

002EH	Spike active energy of last 2 month	4	R	
0030H	Peak active energy of last 2 month	4	R	
0032H	Flat active energy of last 2 month	4	R	
0034H	Valley active energy of last 2 month	4	R	
0036H	Total active energy of last 3 month	4	R	
0038H	Spike active energy of last 3 month	4	R	
003AH	Peak active energy of last 3 month	4	R	
003CH	Flat active energy of last 3 month	4	R	
003EH	Valley active energy of last 3 month	4	R	
0040H~ 0044H	reserve			
0045H	status		R/W	Bit0:0- (EF) , 1- (EEF) ; Bit1:0- (Up and down) , 1- (down and Up) Bit3 : 0-PQS 1-RMS
0046H~ 0047H	reserve			
0048H	parity	2	R	0000:None 0002:Even
0049H	reserve			
004AH				
004BH				
004CH~ 0067H	reserve			
0068H	Current forward active total energy	4	R	unit: 0.01kWh
006AH	Current forward active spike energy	4	R	
006CH	Current forward active peak energy	4	R	
006EH	Current forward active flat energy	4	R	
0070H	Current forward active valley energy	4	R	
0072H	Current reversing active total energy	4	R	
0074H	Current reversing active spike energy	4	R	
0076H	Current reversing Active peak energy	4	R	
0078H	Current reversing active flat energy	4	R	
007AH	Current reversing Active valley energy	4	R	
007C~0 0AFH	reserve			
00B0H	Current total reactive energy	4	R	
00B2H	Current spike reactive energy	4	R	
00B4H	Current peak reactive energy	4	R	
00B6H	Current flat reactive energy	4	R	

00B8H	Current valley reactive energy	4	R	unit: 0.01kVarh
00BAH	Current forward reactive total energy	4	R	
00BCH	Current forward reactive spike energy	4	R	
00BEH	Current forward reactive peak energy	4	R	
00C0H	Current forward reactive flat energy	4	R	
00C2H	Current forward reactive valley energy	4	R	
00C4H	Current reversing reactive total energy	4	R	
00C6H	Current reversing reactive spike energy	4	R	
00C8H	Current reversing reactive peak energy	4	R	
00CAH	Current reversing reactive flat energy	4	R	
00CCH	Current reversing reactive valley energy	4	R	
00CEH~ 52FFH	reserve			
5300H	Voltage	4	R	Float
5302H	Current	4	R	
5304H	Active power	4	R	
5306H	Reactive power	4	R	
5308H	Apparent power	4	R	
530AH	power factor	4	R	
530CH	Frequency	4	R	